

iZone Nova Climate Control System C545K / C535K

Scan the following QR code to get step-by-step instructions on how to install the system or refer to the high level steps below.



✉ supportdesk@izone.com.au

☎ +61 8 6556 6415

Controlling sensor option 1: RETURN AIR

Step 1

Attach the AC Unit Module (C325##) to the CPU module (C225). Connect each damper motor to the CPU zone damper ports starting from zone 1. Connect the AC indoor unit to the CPU module and power it up.

Power up the Smart Hub (COCBH) within 10-15m from the C225 in the home. Do **NOT** connect the CAT5 ethernet cable yet.

Power up the Nova screen within 10-15m of the Smart Hub (COCBH). Do **NOT** connect to

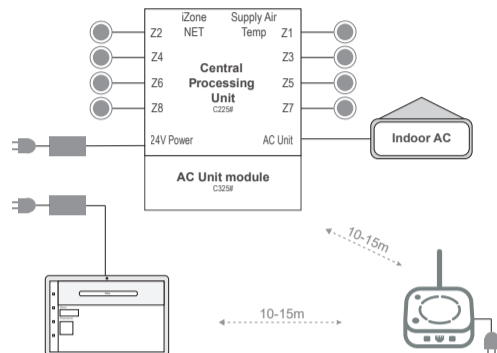

Step 2

Tap on **Setup**, enter your **Installer Code** and hit **Submit**. To get an installer code, go to www.izone.com.au and select SMART INSTALLER from the menu. Register as an installer and receive an email with your installer code.

On the **Air Conditioning Name** screen, enter a name for the system that will appear in the header on the home screen and tap **Continue**.

*Optional - Tap the **Rapid Setup** icon (top right) if you have a rapid setup QR code available.

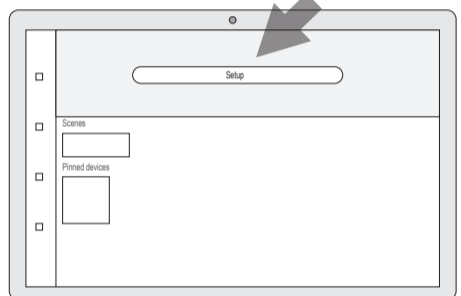

Step 3

Enter the AC Control & Zoning settings and tap **Continue**.

- **Controlling Sensor** = Select 'Return Air Sensor'
- **Number of Zones** = The number of total zone damper motors
- **Constant Control** = Select 'Electronic Constant'
- **Unit Cooling Capacity** = Enter unit cooling capacity
- **Fan Auto** = Enable

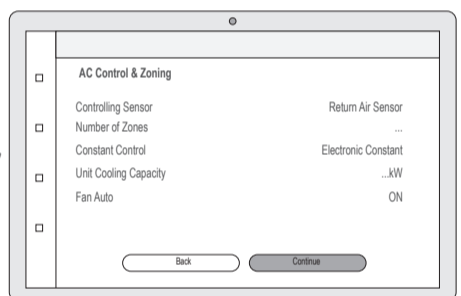

Step 4

Set up each zone and tap **Continue**.

- **Name** = Enter the zone name
- **Type** =
 - i. Select 'Constant without Temp Sensor' for one of the spill zones
 - ii. 'Open/Close Zone' for rest of the zones
- **Area** = Enter the area of the room in m²

After all the zones have been configured, review the **Configuration Summary** and tap **Confirm**. After 2-5 minutes, tap on **Finish**.

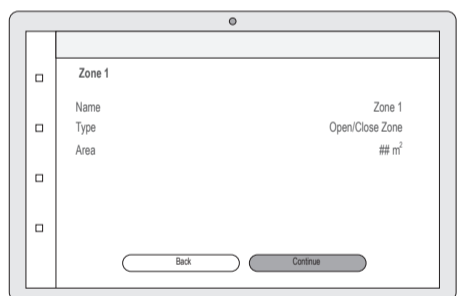

Step 5

The home screen will appear with a pinned tile for each zone.

Commission the system by turning the AC unit on/off and making sure all the zones close and open as expected.

If there is a WiFi router on site, move on to the next step. If no WiFi router available, then stop here.

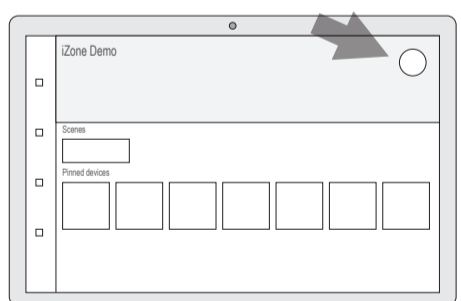

Step 6

If a WiFi router is available on site, connect one side of the blue CAT5 ethernet cable provided to the Smart Hub (COCBH) and the other side to an available LAN port on the WiFi router.

Wait a few seconds for the the globe LED on the Smart Hub (COCBH) to turn on.

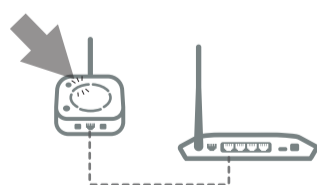

Step 7

Connect the Nova screen to the same WiFi network as the Smart Hub (COCBH) by selecting **MENU** from the navigation bar and tap on **Settings**. Select **WiFi** from the list of settings and connect to the WiFi network. Once done, go back to the HOME screen.

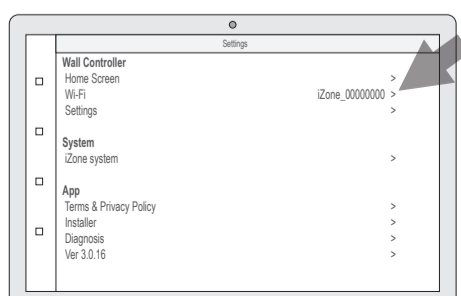

Controlling sensor option 2: ZONE TEMPERATURE SENSORS

Step 1

Attach the AC Unit Module (C325##) to the CPU module (C225). Connect each damper motor to the zone damper ports starting from zone 1. Connect the AC indoor unit to the CPU module and power it up.

Power up the Smart Hub (COCBH) within 10-15m from the C225 in the home. Do **NOT** connect the CAT5 ethernet cable yet.

Power up the Nova screen within 10-15m of the Smart Hub (COCBH). Do **NOT** connect to the home Wifi network.

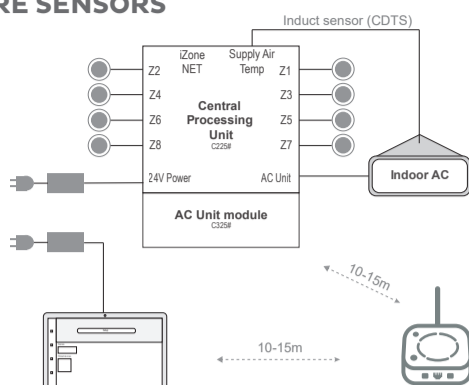

Step 2

Tap on **Setup**, enter your **Installer Code** and hit **Submit**. To get an installer code, go to www.izone.com.au and select SMART INSTALLER from the menu. Register as an installer and receive an email with your installer code.

On the **Air Conditioning Name** screen, enter a name for the system that will appear in the header on the home screen and tap **Continue**.

*Optional - Tap the **Rapid Setup** icon (top right) if you have a rapid setup QR code available.



Step 3

Enter the AC Control & Zoning settings and tap **Continue**.

- **Controlling Sensor** = Zones
- **Number of Zones** = The number of total zone damper motors
- **Constant Control** = Electronic Constant OR Electronic Bypass (if installed)
- **Unit Cooling Capacity** = Enter unit cooling capacity
- **Fan Auto** = Enable

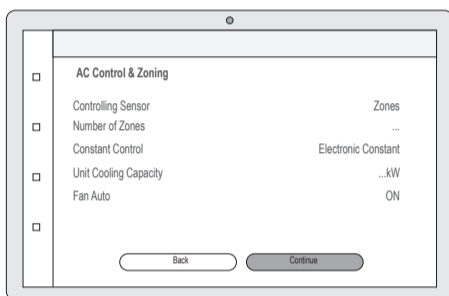

Step 4

Enter the Zone settings and tap **Continue**.

- **Name** = Enter the zone name
- **Type** =
 - Select 'Constant without Temp sensor' for one of the spill zones
 - 'Zone Temp sensor' for rest of the zones
- **Area** = Enter the area of room

After all the zones have been configured, review the **Configuration Summary** and tap **Confirm**. After 2-5 minutes, tap on **Pair Sensors**.

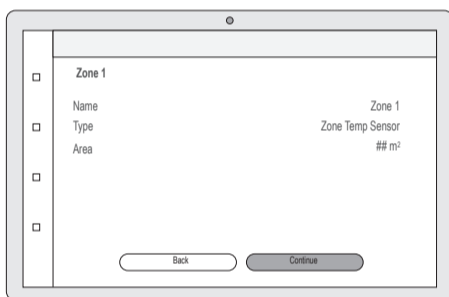

Step 5

Pair the zone temperature sensors.

For **Wireless temperature sensors (CRFSW)**

- Open the front cover, remove the battery tag and change the ZONE potentiometer to correspond with the zone
- Press and hold the **PAIR** button on the zone temperature sensor. The blue **LED** will turn ON
- Press the **Pair** button on the touch screen next to the zone. After a few seconds, the blue LED on the sensor will turn off. Release the **Pair** button on the sensor.

For **Compact temperature sensors (CRFS2)**

- Open the back cover and remove the battery tag
- Press and hold the **PAIR** button on the zone temperature sensor.
- While holding the **PAIR** button, press the **Pair** button on the touch screen next to the corresponding zone. After a few seconds, the button text will change to **Paired** on the screen. Release the **Pair** button on the sensor.

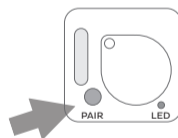
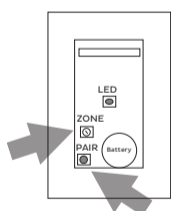

Step 6

Commission the system by turning the AC unit on/off and making sure all the zones close and open as expected.

Wait at least 60 seconds to make sure you see a temperature reading for each zone.

If there is a WiFi router on site, move on to the next step. If no WiFi router available, then stop here.

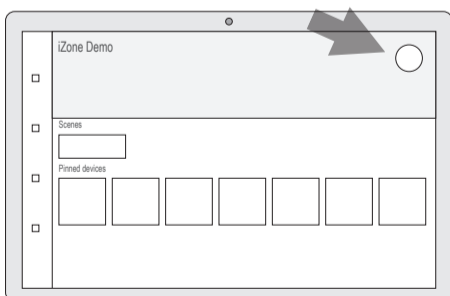

Step 7

If a WiFi router is available on site, connect one side of the blue CAT5 ethernet cable provided to the Smart Hub (COCBH) and the other side to an available LAN port on the WiFi router.

Wait a few seconds for the the globe LED on the Smart Hub (COCBH) to turn on.

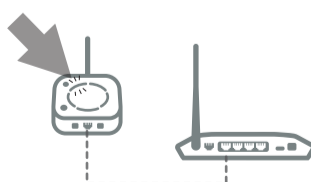

Step 8

Connect the Nova screen to the same WiFi network as the Smart Hub (COCBH) by selecting **MENU** from the navigation bar and tap on **Settings**. Select **WiFi** from the list of settings and connect to the WiFi network. Once done, go back to the HOME screen.

